

# ELFOEnergy Duct Inverter

Air-water ductable liquid chiller for indoor or outdoor installation

## SERIES WSA-XIN 81-131

Nominal cooling capacity (A35/W7) da 15,5 a 27,8 kW



- ▶ HIGH SEASONAL EFFICIENCY
- ▶ DC INVERTER COMPRESSOR
- ▶ PLUG-FAN DC INVERTER FAN



DC Inverter



Clivet is taking in the EUROVENT certification programme up to 1.500 kW. The products concerned appear in the certified products list of the EUROVENT [www.eurovent-certification.com](http://www.eurovent-certification.com) site.

# Clivet hydronic system

Designed to provide high energy efficiency and sustainability of the investment, the wide range of Clivet liquid chillers and heat pumps for high efficiency air conditioning of Residential and Commercial spaces and for Industrial applications it is available with air or water source.

## HYDRONIC System - Air Source

	Piccolo e Medio Terziario			Grande Terziario e Industria		
	ELFOEnergy Extended Inverter ELFOEnergy Extended Inverter Duct	ELFOEnergy Medium / Vulcan / Large <sup>2</sup> ELFOEnergy Duct Medium	ELFOEnergy Magnum	SPINchiller <sup>2</sup> / SPINchiller Duct Modular Scroll Technology		SCREWLine <sup>1</sup>
Potenze (ASL/W7)	5 + 31 kW	25 + 250 kW	30 + 250 kW	270 + 680 kW	710 + 1360 kW	460 + 1420 kW
	WSAT-XIN iDC Inverter	WSAT-XEE PRM	WSAT-XIN iDC Inverter PRM	WSAT-XSC3 PRM	WSAT-XSC3 PRM	WDAT-SL3 PRM
			WSAT-XIN HA iDC Inverter	WSAT-XSC3	WSAT-XSC3	WDAT-SL3
		WSAT-XEE (FC)	WSAT-XIN FC	WSAT-XSC3 FC	WSAT-XSC3 FC	WDAT-SL3 FC
	WSAN-XIN iDC Inverter	WSAN-XEE	WSAN-XIN iDC Inverter PRM	WSAN-XSC3 PRM	WSAN-XSC3 PRM	
		WBAN	WSAN-XIN HW			
	WSA-XIN iDC Inverter	WSA-XEE	WSAN-XIN MF iDC Inverter PRM	WSAN-XSC3 MF PRM	WSAN-XSC3 MF PRM	
	WSA-XIN (refrigerazione) WSAN-XIN (pompa di calore)	WSA-XEE (refrigerazione) WSA-XEE (pompa di calore)		WSA-XSC2 (refrigerazione)		

### The ventilation with thermodynamic recovery

Air renewal determines comfort levels in rooms: it often represents the building's main energy load



ELFOFresh<sup>2</sup>  
Mechanical ventilation system with energythermodynamic recovery

- It multiplies the recovered energy
- It reduces the main generator power
- Summer dehumidification for the matching to the radiant system
- It cools free (FREE-COOLING) in specific conditions
- PM10, pollens, bacteria and nanoparticles are eliminated thanks to the electronic filter

### Complete management of the system

In integrated systems, control over the various elements is essential for correct management and increased seasonal efficiency

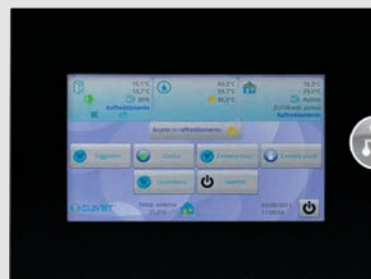

ELFOControl<sup>2</sup>  
System domotics based on advanced algorithms to optimise energy and comfort

- Complete installation control
- Time schedule
- Customised comfort levels
- Optimization of the seasonal efficiency
- Communication with the room thermostat for temperature and humidity control.

## ELFOEnergy Duct Inverter, two solutions to satisfy different installation needs

### COOLING ONLY WSA-XIN:

- Water cooler
- Capacity from 15,5 to 27,8 kW



### HEAT PUMP WSN-XIN:

- Reversible-cycle heat pump
- Capacity from 15,5 to 29,1 kW



# ELFOEnergy Duct Inverter is the heart of ELFOSystem

A single, intelligent system with all the elements for year-round comfort

- ▶ Cooling
- ▶ Fresh air renewal and purification
- ▶ Dehumidification

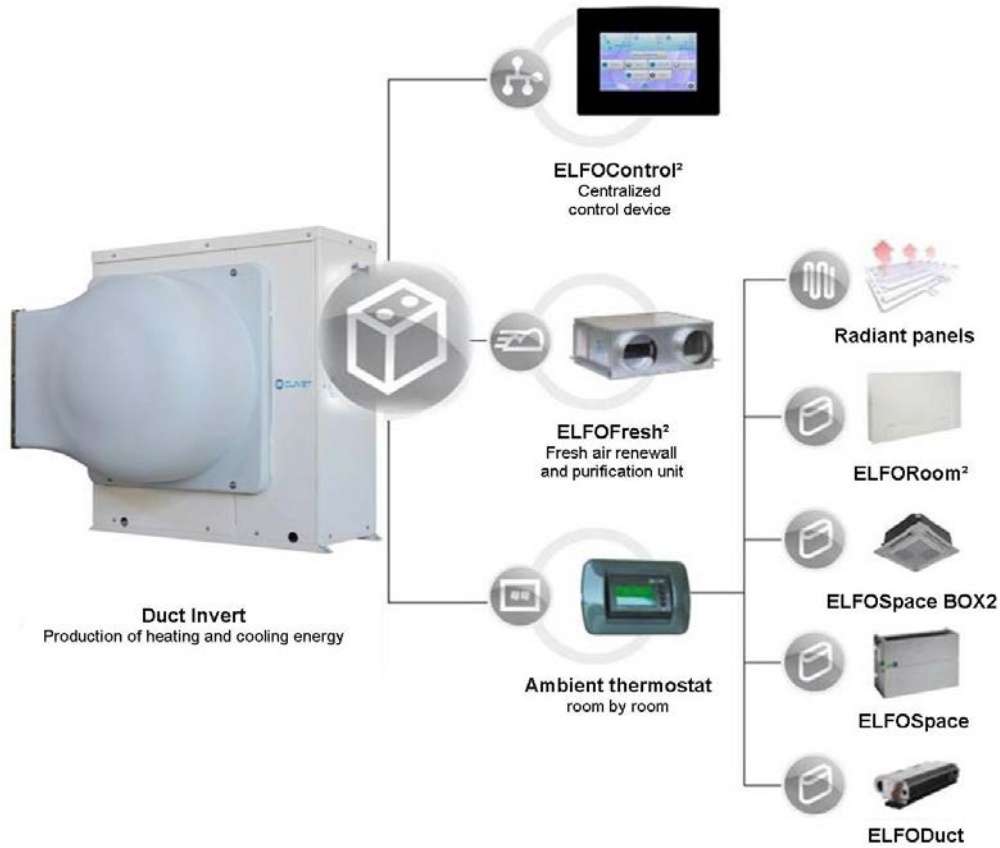

## System components



### ELFOEnergy Duct Inverter

- Heat pump at high seasonal efficiency
- Inverter technology
- 100% silent operation
- Compact dimensions



### ELFOControl²

- Advanced control system to manage the operation of the whole flat
- Optimisation of performance and operation
- Simply to use and complete system management



### ELFOFresh²

- Energy-recovery based room ventilation and purification
- Active thermodynamic recovery
- Electronic filtering
- Summer dehumidification
- FREE-COOLING



### Fan coil units

- Wide range of room terminals to adapt to any installation requirement, with temperature control for room
- Compact design and small size
- Continuous speed variation
- Homogenous temperature
- Reduced consumptions

## Advanced technology and benefits

### Inverter compressor

The inverter compressor can continuously modulate the cooling capacity from 40% to 100%.

This allows the delivered capacity to be set according to the demand on the system. Very high efficiency values can be achieved, especially under load staging conditions that coincide with most of the operating time.

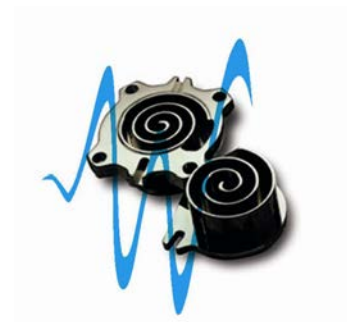

### Thermostatic electronics

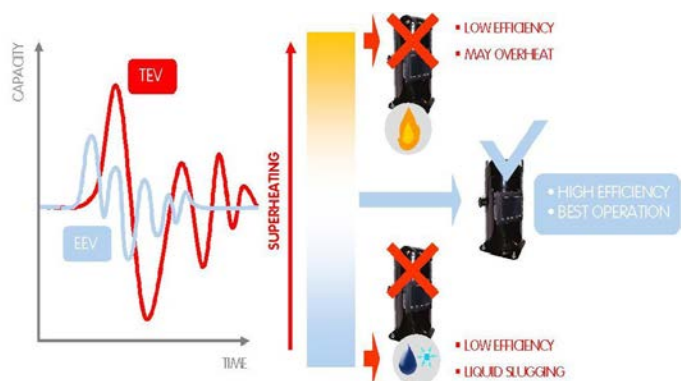

The thermostatic electronic expansion valve (TEE) adapts quickly and precisely to the effective load required for use, permitting a stable and accurate adjustment and optimal operation of the compressor.

There is also an additional increase in efficiency in comparison to traditional thermostatic mechanical valves (TEM) and a longer compressor life.

### Special design features

- 1. The outdoor air probe** allows setting the ideal climate in relation to environmental conditions
- 2. The built-in display** shows all the operating parameter settings
- 3. The Electronic Thermostat** Optimises the operation conditions of the refrigeration circuit
- 4. The plate heat exchanger** maximises the thermal efficiency thanks to large exchange surfaces
- 5. The Inverter DC Compressor** allows high seasonal efficiency thanks to the modulation
- 6. Plug-fan DC Inverter fan** thanks to the flow rate modulation reduces the sound emissions and the fan consumptions.
- 7. The Hydrophilic Battery** ensures a better cleaning maintaining thermal exchange efficiency and reduced defrost time
- 8. Water kit:** kit that simplifies the hydronic circuit, reduces the overall dimensions and allows an easier maintenance

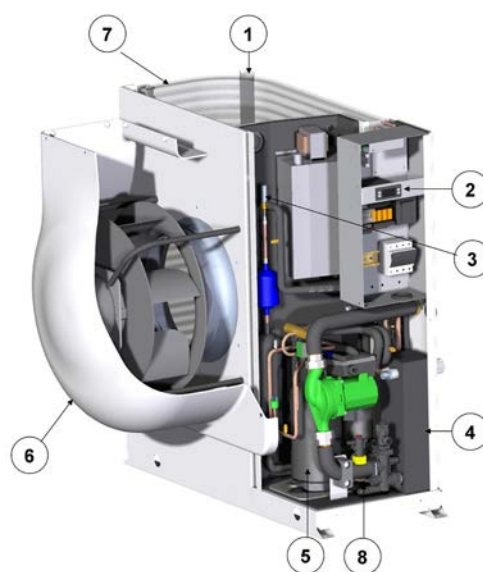

## Intelligent energy management

The Extended Inverter electronic control allows producing energy in the required quantity and in the most efficient and effective way in relation to the outdoor conditions and requirements of the building.

### Everything IS UNDER CONTROL



The electronic control with built-in display the unit allows defining the operation parameters with maximum simplicity. Once set, the control manages automatically the operation of the unit.

- setting the supply water set point
- climate compensation
- time schedule

### Outdoor climatic compensation

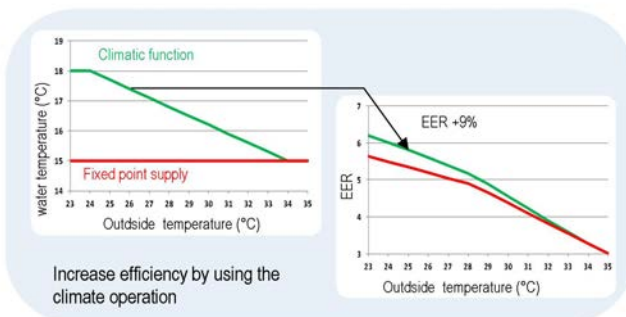

The water temperature for the system is adjusted automatically in relation to the real requirements of the building and outdoor air temperature, increasing the seasonal energy efficiency.

### Remote control (RCTX option)

The RCTX remote control, is provided with a large and easy to read display. Programming, using only 4 keys, is intuitive and simple.

- The device can also:
  - control the unit's operation
  - activate the circulation of the system's water
  - set the unit set point water temperature according to time bands
- The RCTX also works in "remote control", making it even easier to configure and control the unit's operation. It can:
  - set the ON/OFF control
  - read the information detected by the device installed on board the unit, as the operation status, parameters and alarms.



## Unit configuration

Model					
WSA-XIN	81	91	101	121	131

Supply voltage					
400/3/50 + N	std	std	std	std	std

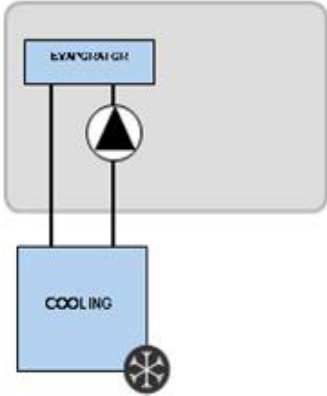
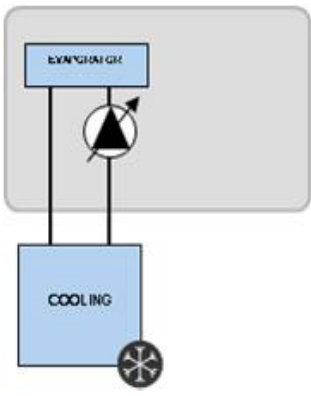
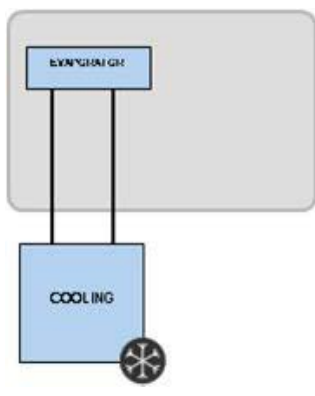
Functionalities	Hydronic units		
<p><b>2</b> <b>PIPE SYSTEM</b></p> <p>Chilled water production for installation</p>	<p><b>1.1</b> Standard unit</p> 	<p><b>1.2</b> Unit with high efficiency hydronic assembly</p> 	<p><b>1.3</b> Unit without hydronic assembly</p> 

Accessories separately supplied		
<ul style="list-style-type: none"> <li>• <b>RCTX</b> - Remote control</li> <li>• <b>CMSC2X</b> - Serial communication module with RS485 serial converter kit</li> <li>• <b>KG4UP</b> - Management kit up to 4 units in parallel</li> </ul>	<ul style="list-style-type: none"> <li>• <b>KTFL2X</b> - 1"1/4 water side hose kit</li> </ul>	<ul style="list-style-type: none"> <li>• <b>AMRX</b> - Rubber antivibration mounts</li> <li>• <b>KSAX</b> - 100-litre circuit breaker</li> <li>• <b>GMX</b> - Outlet grille</li> </ul>

## General technical data

Size			81	91	101	121	131
<b>Radiant panels</b>							
<b>Cooling</b>							
Cooling capacity	1	kW	16,0	18,8	21,0	26,5	29,5
Total power input	2	kW	4,19	5,16	6,03	7,09	8,40
EER (EN 14511: 2013)	3		3,82	3,63	3,48	3,73	3,51
Water flow-rate	1	l/s	0,76	0,90	1,00	1,27	1,41
Useful pump discharge head	1	kPa	69	62	56	52	42
<b>Terminal units</b>							
<b>Cooling</b>							
Cooling capacity	5	kW	15,5	17,5	19,6	25,3	27,8
Total power input	2	kW	5,50	6,58	8,12	9,54	11,2
EER (EN 14511: 2013)	3		2,82	2,65	2,42	2,65	2,48
SEER	6		4,54	4,64	4,14	4,06	3,90
Water flow-rate	4	l/s	0,74	0,84	0,94	1,21	1,33
Useful pump discharge head	4	kPa	70	65	60	55	48
<b>Compressor</b>							
Type of compressors	SCROLL INVERTER DC						
Refrigerant			R-410A	R-410A	R-410A	R-410A	R-410A
No. of compressors		No	1	1	1	1	1
Oil charge		l	1,90	1,90	1,90	1,90	1,90
Refrigeration circuits		No	1	1	1	1	1
Refrigerant charge		kg	4,7	4,7	4,7	6,8	6,8
<b>User side exchanger</b>							
Type of exchanger	7		PHE	PHE	PHE	PHE	PHE
No. of exchangers			1	1	1	1	1
Water content		l	2,37	2,37	2,37	3,13	3,13
<b>External Section Fans</b>							
Type of fans	8		RAD	RAD	RAD	RAD	RAD
No. of fans		No	1	1	1	1	1
Standard airflow		l/s	2167	2389	2444	3333	3889
Installed unit power		kW	0,67	0,74	0,76	1,28	1,75
Max external static pressure		Pa	120	120	120	120	120
<b>Water circuit</b>							
Maximum water side pressure		kPa	550	550	550	550	550
Safety valve calibration		kPa	600	600	600	600	600
Min. installation water contents		l	50	53	57	63	68
<b>Power supply</b>							
Standard power supply			400/3/50+N	400/3/50+N	400/3/50+N	400/3/50+N	400/3/50+N

The Product is compliant with the Erp (Energy Related Products) European Directive. It includes the Commission delegated Regulation (EU) No 2016/2281, also known as Ecodesign Lot21.

\*Contains fluorinated greenhouse gases\*(GWP 2087,5)

1. Entering/leaving water temperature user side 23/18°C, external exchanger entering air 35°C
2. The overall power absorbed is calculated by adding the power absorbed by the compressor + the power absorbed by the fans + the power absorbed by the auxiliary electrical circuit + the percentage value of the pump to overcome pressure drops inside the unit
3. EER (EN 14511:2013) cooling performance coefficient. Ratio between delivered cooling capacity and power input in compliance with EN 14511:2013
4. User side entering/leaving water temperature 12/7 °C, external exchanger entering air 35°C
5. Data calculated according to the EN 14825:2016 Regulation
6. PHE = Plate exchanger
7. RAD = Radial fan

The heads are intended as available at the unit connections

The pressure drops of the steel mesh strainer, supplied with the unit, have been already taken into consideration



# Electrical data

## Supply voltage 400/3/50+N

Size		81	91	101	121	131
<b>F.L.A. - Full load current at max admissible conditions</b>						
F.L.A. - Pump	A	1,90	1,90	1,90	1,90	1,90
F.L.A. - Fan	A	4,10	4,10	4,10	4,10	4,10
F.L.A. - Total	A	27,83	28,13	28,93	31,53	33,53
<b>F.L.I. - Full load power input at max admissible conditions</b>						
F.L.I. - Pump	kW	0,39	0,39	0,39	0,39	0,39
F.L.I. - Fan	kW	2,70	2,70	2,70	2,70	2,70
F.L.I. - Total	kW	9,68	10,68	12,28	14,38	16,68
<b>M.I.C. Maximum inrush current</b>						
M.I.C. - Value	A	27,83	28,13	28,93	31,53	33,53

Power supply: 400/3/50 Hz. Voltage variation: max. +/-10%

Voltage unbalance between phases: max 2 %

The pump is included in the total values calculation

for non standard voltage please contact Clivet technical office

The units are compliant with the provisions of European standards CEI EN 60204 and CEI EN 60335.

# Operating range

## Cooling

### ELFOEnergy Duct Inverter 81-131

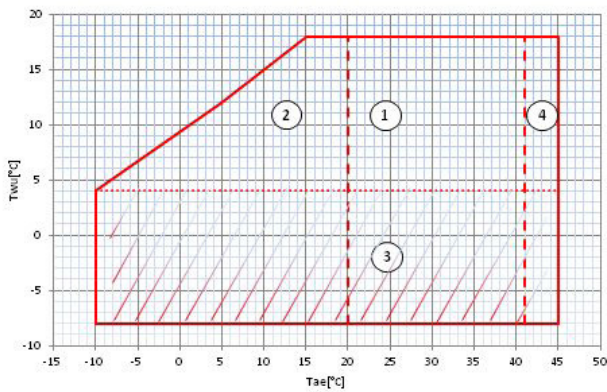

$T_{wu}$  [°C] = leaving exchanger water temperature

$T_{se}$  [°C] = external exchanger inlet air temperature

1. Normal operating range
2. Normal operating range, with modulating fans
3. Operating range where the use of ethylene glycol is mandatory in relation to the temperature of the water at the outlet of the user side exchanger
4. Operating range with modulating compressor

## Unit sound levels

$\Delta P_{ut}$ [Pa]	Size	Sound pressure level [dB(A)]	Sound power level [dB(A)]
80	<b>81</b>	48	65
80	<b>91</b>	48	65
80	<b>101</b>	51	67
80	<b>121</b>	52	69
80	<b>131</b>	53	70

The noise levels refer to units at full load under nominal test conditions, with ducted supply and return and available pressure of 50Pa and 80Pa as indicated in the table.

The sound pressure level refers to a distance of 1m from the outer surface of the unit operating in an open field.

Noise levels are determined using the tensiometric method (UNI EN ISO 9614-2)

Data referred to the following conditions:

entering / leaving user side exchanger water T 12/7°C, source side air T 35°C

## Supply sound levels

$\Delta P_{ut}$ [Pa]	Size	Sound power level								Sound pressure level	Sound power level
		Octave band (Hz)									
		63	125	250	500	1000	2000	4000	8000		
120	<b>81</b>	104	94	78	73	71	70	69	56	<b>72</b>	<b>82</b>
120	<b>91</b>	105	94	78	73	71	69	69	58	<b>73</b>	<b>82</b>
120	<b>101</b>	107	96	81	74	72	70	69	60	<b>74</b>	<b>84</b>
120	<b>121</b>	106	100	86	81	78	77	70	65	<b>77</b>	<b>87</b>
120	<b>131</b>	107	103	89	85	82	81	75	69	<b>81</b>	<b>91</b>

The noise levels refer to units at full load, under nominal test conditions with ducted supply.

The sound pressure level is measured on the outlet with 1 meter duct and available pressure of 100Pa and 120Pa as indicated in the table.

Noise levels are determined using the tensiometric method (UNI EN ISO 9614-2)

Data referred to the following conditions:

entering / leaving user side exchanger water T 12/7°C, source side air T 35°C

## Admissible water flow rates

Min. (Qmin) and max. (Qmax) water flow-rates admissibles for the correct unit operation.

Size		81	91	101	121	131
Minimum flow	[l/s]	0,32	0,32	0,32	0,45	0,45
Maximum flow-rate	[l/s]	1,70	1,70	1,70	1,90	1,90

## Correction factors for glycol use

% ethylene glycol by weight			5%	10%	15%	20%	25%	30%	35%	40%
Freezing temperature		°C	-2,0	-3,9	-6,5	-8,9	-11,8	-16,6	-19,0	-23,4
Safety temperature		°C	3	1	-1	-4	-6	-10	-14	-19
Cooling Capacity Factor		No	0,995	0,990	0,985	0,981	0,977	0,974	0,971	0,968
Compressor power input Factor		No	0,997	0,993	0,990	0,988	0,986	0,984	0,982	0,981
Internal exchanger glycol solution flow factor		No	1,003	1,010	1,020	1,033	1,050	1,072	1,095	1,124
Pressure drop Factor		No	1,029	1,060	1,090	1,118	1,149	1,182	1,211	1,243

The correction factors shown refer to water and glycol ethylene mixes used to prevent the formation of frost on the exchangers in the water circuit during inactivity in winter.

## Fouling Correction Factors

m <sup>2</sup> C/W	Internal exchanger	
	F1	FK1
0,44x10 <sup>(-4)</sup>	1,00	1,00
0,44x10 <sup>(-4)</sup>	0,97	0,99
0,44x10 <sup>(-4)</sup>	0,94	0,98

The cooling performance values provided in the tables are based on the external exchanger having clean plates (fouling factor 1). For different fouling factor values, multiply the performance by the coefficients shown in the table.

F1 = Cooling capacity correction factors

FK1 = Compressor power input correction factor

# Standard unit technical specifications

## Compressor

Size 81-131

Inverter controlled scroll-type hermetic compressor equipped with a motor protection device for overheating, overcurrents and excessive temperatures of the supply gas. It is installed on anti-vibration mounts and is equipped with oil charge.

An oil heater, which starts automatically, keeps the oil from being diluted by the refrigerant when the compressor stops.

## Structure

Structure made entirely in Zinc–Magnesium plate that guarantees excellent mechanical characteristics and high corrosion strength over time.

base made from galvanized steel plate painted with polyester powder paint, RAL 9001.

## Panelling

External panels made with prepainted zinc-magnesium, especially indicated in outdoor installation due to its superior resistance to corrosion avoiding periodic painting. Side panels are easily removable and allow complete access to unit components.

## Internal exchanger

Direct expansion heat exchanger with braze welded stainless steel INOX AISI 316 plates and complete with external thermal/anti-condensation insulation.

The exchanger is complete with:

- antifreeze heater to protect the water side exchanger, preventing the formation of frost if the water temperature falls below a set value.

## External exchanger

Direct expansion finned coil exchanger made with copper pipes placed on staggered rows mechanically expanded to better adhere to the fin collar. The fins are made from aluminium with a corrugated surface and adequately distanced to ensure the maximum heat exchange efficiency.

## Fan

Direct current radial fan, reversed blades, optimised to reduce at minimum the sound emissions and at the same time increase the energy efficiency, though keeping the pressure necessary to the unit duct system.

## Refrigeration circuit

Refrigeration circuit with:

- electronic expansion valve
- filter dryer
- pressure probes
- low pressure safety
- high pressure safety

## Front return plenum

Magnesium zinc metal plate structure that allows the return duct to be easily connected.

## Electrical panel

The capacity section includes:

- fans and auxiliary circuit fuse
- compressor fuses
- isolating transformer for auxiliary circuit power supply

The control section includes:

- compressor overload protection and timer
- relay for remote cumulative fault signal
- condenser control
- Set point compensation with outdoor temperature
- ON/OFF clear input

The control keypad includes:

- Multifunction keys for ON/OFF control, cold and hot operation mode, display and alarm reset, daily or weekly schedule
- Display

## Water circuit

- water side safety valve
- drain valve
- Steel mesh strainer
- Flow Switch
- pump

## Accessories

- AMRX - Rubber antivibration mounts
- RCTX - Remote control
- CMSC2X - Serial communication module with RS485 serial converter kit
- KTFL2X - 1" 1/4 water side hose kit
- KSAX - 100-litre circuit breaker
- GMX - Outlet grille
- PGFCX - Finned coil protection grill
- KG4UP - Management kit up to 4 units in parallel

# Hydronic assembly configuration 1.1

## Standard unit

Standard unit is equipped with wet rotor, pipe union connection and max operating pressure at 6 bar.

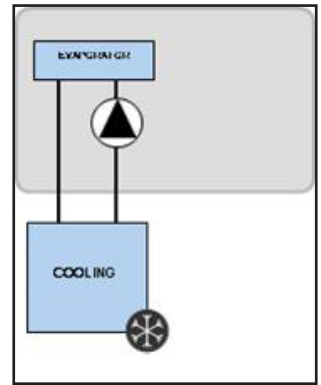

## Curve of discharge head with standard circulator

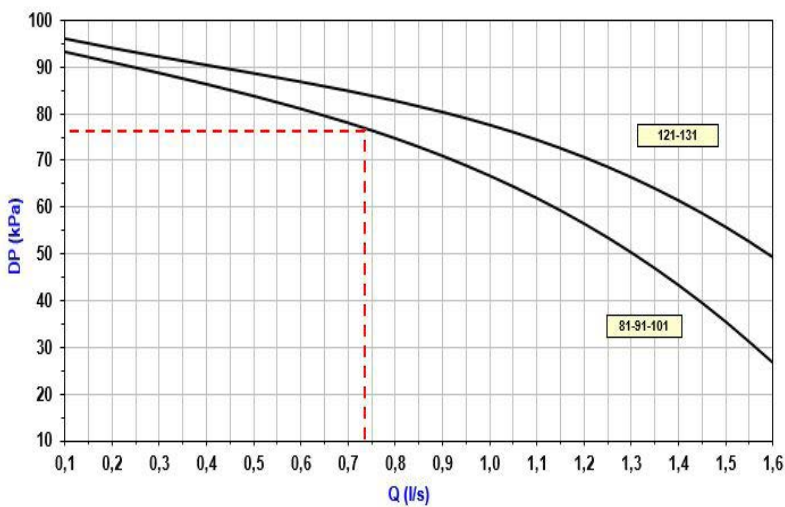

Available pressure curves with hydronic assembly

DP = Available pressure [kPa]  
Q = Water flow-rate [l/s]

The heads are intended as available at the unit connections

The pressure drops of the steel mesh strainer, supplied with the unit, have been already taken into consideration

## Standard circulator absorption curves

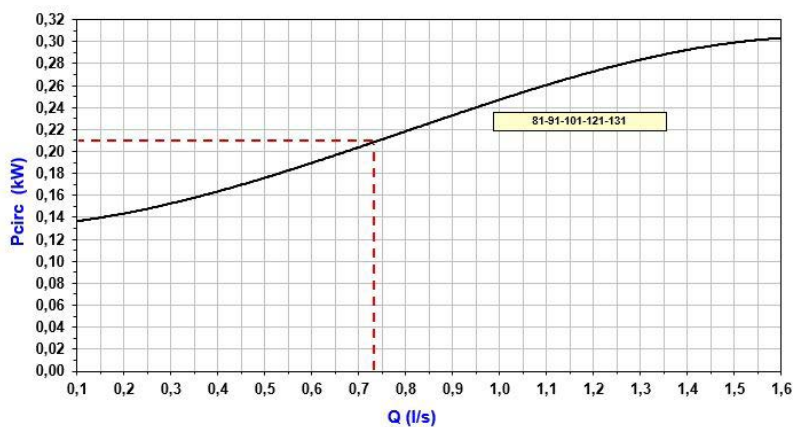

Available pressure curves with hydronic assembly

DP = Available pressure [kPa]  
Q = Water flow-rate [l/s]

the heads are intended as available at the unit connections

The pressure drops of the steel mesh strainer, supplied with the unit, have been already taken into consideration

## Hydronic assembly configuration 1.2

### Unit with high efficiency hydronic assembly - HYHE

The EC technology decisively reduces the annual consumption of electric energy, thereby allowing for considerable cost savings compared to conventional motors.

The EC circulator use allows to chose the optimal operating curve according to the charge and the installation pressure drop and allows to exceed the traditional operating ranges.

A series of automatically-activated devices assure the unit operation even when the system water is under critical conditions, that would lock the operation of the old generation units:

if the water temperature exceeds the maximum operating temperature, the electronic control decreases the circulator's water flow-rate.

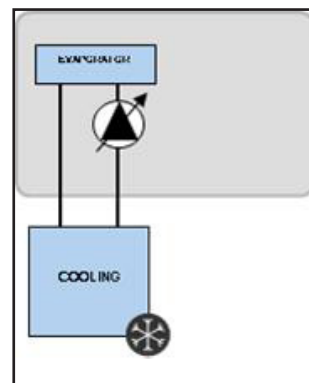

### Available pressure curves with high-efficiency circulator

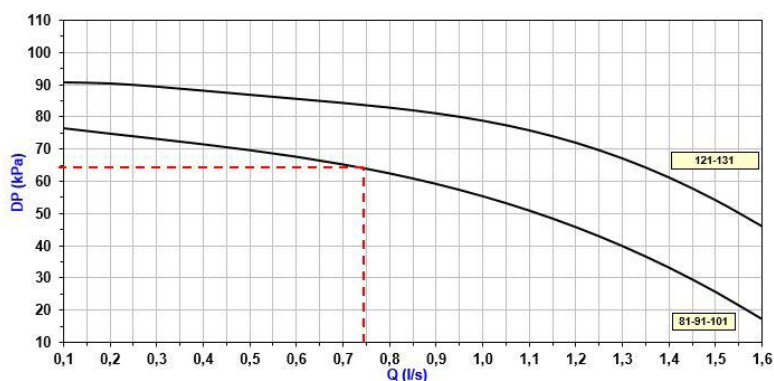

Available pressure curves with hydronic assembly

Q = Water flow-rate [l/s]  
DP = Available pressure [kPa]

The heads are intended as available at the unit connections

The pressure drops of the steel mesh strainer, supplied with the unit, have been already taken into consideration

### High-efficiency circulator absorption curves

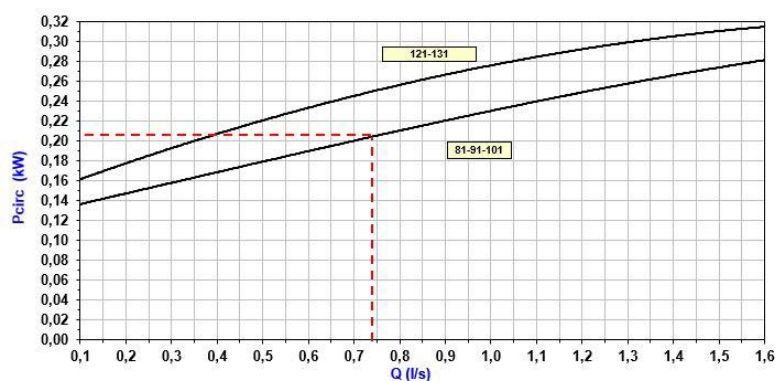

Q = Water flow-rate [l/s]  
P<sub>circ</sub> = Capacity absorbed by the pump [kW]

# Hydronic assembly configuration 1.3

## Unit without hydronic assembly

The unit can be requested without the hydronic assembly, consisting solely of the circulation pump

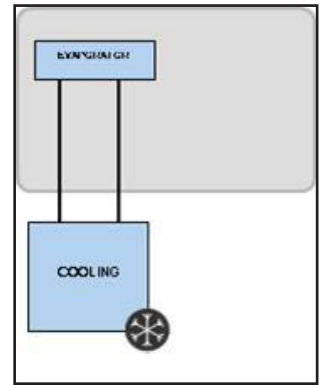

### Exchanger pressure drop curves + steel mesh filter

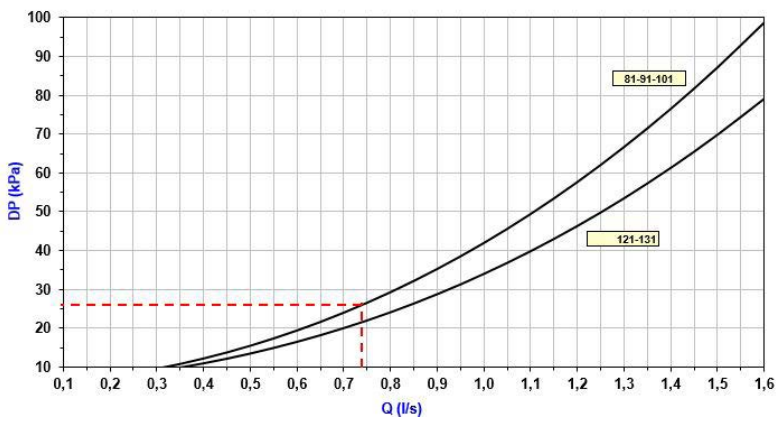

Exchanger pressure drop limit + filter Caution: do not use beyond this limit.

$Dp$  = pressure drop  
 $Q$  = water flow

Exchanger pressure drop limit + filter. Caution: do not use below this limit



# Control

## Climatic compensation with ambient temperature

The cooling capacity requirement of the building cooling decreases with the ambient temperature reduction

Power supply is not necessary for the terminal units always at the same temperature; for each kind of terminal unit it is better to have a water temperature that changes according with ambient temperature, with linear trend (what is commonly defined climatic control) for a high seasonal energy efficiency.

The following graph shows an example of climatic control on the water supply temperature.

### Climatic curve in Cooling

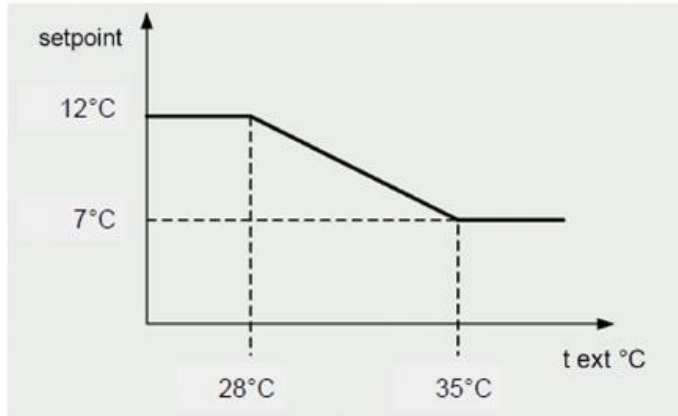

With a decreasing ambient temperature, the climatic function increases the supply water set point

Set point = 7°C  
Compensated set point = 12°C

# WSA-XIN 81 Performance

## Cooling

To	Tae	Cooling capacity						EER					
		100%	80%	75%	60%	50%	40%	100%	80%	75%	60%	50%	40%
5	20	17,3	15,8	13,6	11,4	10,1	8,69	4,19	4,42	4,79	5,22	5,54	6,01
	25	16,5	15,1	12,9	10,8	9,42	8,08	3,64	3,81	4,08	4,38	4,60	4,93
	30	15,7	14,3	12,2	10,2	8,89	7,60	3,19	3,30	3,49	3,70	3,86	4,08
	35	14,7	13,3	11,4	9,51	8,32	7,13	2,72	2,80	2,93	3,07	3,18	3,32
	40	13,4	12,3	10,5	8,85	7,79	6,72	2,30	2,36	2,45	2,55	2,62	2,72
	45	12,3	11,2	9,76	8,31	7,39	6,48	1,93	1,98	2,06	2,14	2,20	2,27
7	20	18,5	16,8	14,3	12,0	10,5	8,94	4,37	4,62	5,03	5,52	5,90	6,48
	25	17,6	15,9	13,6	11,2	9,75	8,28	3,79	3,97	4,26	4,61	4,87	5,27
	30	16,7	15,1	12,8	10,6	9,18	7,77	3,30	3,43	3,64	3,88	4,06	4,33
	35	15,5	14,1	12,0	9,90	8,59	7,29	2,82	2,91	3,06	3,22	3,34	3,52
	40	14,3	13,0	11,1	9,23	8,07	6,90	2,39	2,46	2,56	2,67	2,76	2,88
	45	13,1	12,0	10,3	8,74	7,72	6,70	2,02	2,08	2,16	2,26	2,32	2,41
12	20	21,3	19,3	16,2	13,3	11,4	9,58	4,81	5,12	5,64	6,27	6,79	7,65
	25	20,1	18,2	15,2	12,4	10,6	8,80	4,15	4,37	4,74	5,18	5,54	6,13
	30	19,0	17,1	14,3	11,6	9,90	8,19	3,59	3,75	4,01	4,31	4,56	4,95
	35	17,7	15,9	13,4	10,9	9,28	7,69	3,08	3,20	3,38	3,59	3,76	4,01
	40	16,4	14,8	12,5	10,2	8,76	7,33	2,62	2,70	2,83	2,98	3,10	3,27
	45	15,3	13,9	11,8	9,81	8,54	7,27	2,24	2,31	2,42	2,54	2,63	2,77
15	20	22,8	20,7	17,7	14,7	12,8	11,0	4,96	5,29	5,84	6,51	7,04	7,89
	25	21,6	19,6	16,6	13,7	11,9	10,1	4,29	4,52	4,92	5,39	5,76	6,35
	30	20,4	18,5	15,7	12,9	11,2	9,45	3,72	3,89	4,17	4,50	4,76	5,15
	35	19,0	17,2	14,6	12,1	10,5	8,85	3,18	3,30	3,49	3,72	3,89	4,15
	40	17,6	16,0	13,6	11,4	9,90	8,45	2,71	2,80	2,94	3,10	3,23	3,40
	45	16,6	15,2	13,1	11,0	9,71	8,42	2,36	2,43	2,56	2,69	2,79	2,93
18	20	24,7	22,6	19,4	16,3	14,4	12,4	5,38	5,77	6,43	7,21	7,82	8,78
	25	23,3	21,2	18,2	15,2	13,3	11,4	4,61	4,89	5,36	5,92	6,35	7,01
	30	21,9	19,9	17,0	14,2	12,4	10,6	3,96	4,17	4,50	4,89	5,19	5,64
	35	20,5	18,7	16,0	13,3	11,7	10,0	3,42	3,57	3,82	4,09	4,30	4,61
	40	19,1	17,4	14,9	12,5	11,0	9,52	2,93	3,04	3,22	3,42	3,57	3,78
	45	18,3	16,8	14,5	12,4	11,0	9,63	2,60	2,70	2,86	3,04	3,16	3,33

To = Leaving internal exchanger water temperature (°C)

Tae [°C] = External exchanger inlet air temperature

Performances in function of the inlet/outlet water temperature differential = 5°C

Cooling capacity and EER calculated according to EN 14511:2013

# WSA-XIN 91 Performance

## Cooling

To	Tae	Cooling capacity						EER					
		100%	80%	75%	60%	50%	40%	100%	80%	75%	60%	50%	40%
5	20	19,6	18,0	16,2	12,7	11,1	9,40	3,86	4,06	4,31	4,87	5,18	5,66
	25	18,6	17,1	15,3	12,0	10,4	8,73	3,37	3,51	3,69	4,09	4,31	4,64
	30	17,7	16,2	14,5	11,3	9,75	8,20	2,95	3,06	3,18	3,46	3,61	3,83
	35	16,5	15,2	13,6	10,6	9,15	7,71	2,54	2,62	2,71	2,89	3,00	3,15
	40	15,2	14,0	12,5	9,85	8,56	7,27	2,15	2,21	2,28	2,41	2,48	2,59
	45	13,9	12,9	11,6	9,28	8,16	7,03	1,80	1,85	1,91	2,02	2,08	2,17
7	20	20,9	19,1	17,2	13,4	11,5	9,71	4,07	4,29	4,58	5,20	5,56	6,13
	25	19,8	18,2	16,2	12,5	10,8	9,00	3,54	3,70	3,91	4,35	4,60	4,99
	30	18,7	17,2	15,4	11,8	10,1	8,44	3,09	3,21	3,35	3,66	3,83	4,10
	35	17,5	16,1	14,3	11,1	9,50	7,92	2,65	2,74	2,84	3,05	3,17	3,35
	40	16,1	14,8	13,2	10,3	8,89	7,48	2,25	2,32	2,39	2,54	2,63	2,75
	45	14,9	13,8	12,4	9,81	8,56	7,31	1,92	1,98	2,04	2,17	2,24	2,34
12	20	24,0	22,0	19,6	14,9	12,7	10,5	4,60	4,88	5,24	6,02	6,50	7,29
	25	22,7	20,8	18,5	14,0	11,8	9,66	3,97	4,19	4,44	4,99	5,33	5,87
	30	21,4	19,7	17,4	13,1	11,1	9,02	3,44	3,60	3,78	4,17	4,40	4,77
	35	19,9	18,3	16,2	12,3	10,4	8,45	2,94	3,06	3,18	3,45	3,61	3,85
	40	18,3	16,9	15,0	11,4	9,71	7,99	2,49	2,59	2,68	2,87	2,98	3,15
	45	17,4	16,1	14,4	11,1	9,56	8,01	2,21	2,30	2,38	2,55	2,64	2,78
15	20	25,7	23,6	21,2	16,4	14,2	11,9	4,65	4,96	5,34	6,18	6,69	7,51
	25	24,3	22,4	20,0	15,4	13,2	11,0	4,04	4,28	4,55	5,15	5,51	6,08
	30	23,0	21,1	18,9	14,5	12,4	10,3	3,53	3,71	3,90	4,32	4,57	4,96
	35	21,4	19,7	17,6	13,5	11,6	9,66	3,02	3,16	3,30	3,59	3,76	4,02
	40	19,8	18,3	16,4	12,7	11,0	9,19	2,58	2,69	2,79	3,00	3,13	3,31
	45	19,0	17,6	15,8	12,5	10,9	9,29	2,28	2,37	2,46	2,65	2,76	2,91
18	20	27,3	25,2	22,7	17,8	15,5	13,2	5,06	5,42	5,88	6,88	7,46	8,40
	25	25,8	23,8	21,4	16,7	14,4	12,2	4,40	4,67	5,00	5,73	6,14	6,80
	30	24,3	22,4	20,1	15,6	13,5	11,3	3,83	4,04	4,28	4,80	5,09	5,54
	35	22,7	20,9	18,8	14,6	12,6	10,6	3,29	3,46	3,63	4,00	4,21	4,52
	40	21,1	19,5	17,5	13,8	12,0	10,2	2,84	2,97	3,10	3,38	3,53	3,75
	45	20,6	19,1	17,3	13,8	12,1	10,4	2,55	2,67	2,79	3,03	3,17	3,36

To = Leaving internal exchanger water temperature (°C)

Tae [°C] = External exchanger inlet air temperature

Performances in function of the inlet/outlet water temperature differential = 5°C

Cooling capacity and EER calculated according to EN 14511:2013

# WSA-XIN 101 Performance

## Cooling

To	Tae	Cooling capacity						EER					
		100%	80%	75%	60%	50%	40%	100%	80%	75%	60%	50%	40%
5	20	22,6	20,7	17,8	14,7	12,7	10,8	3,72	3,88	4,20	4,67	4,99	5,36
	25	21,3	19,5	16,9	13,8	11,9	10,0	3,20	3,34	3,58	3,91	4,13	4,39
	30	20,0	18,4	15,9	13,0	11,2	9,36	2,76	2,88	3,06	3,29	3,44	3,62
	35	18,5	17,1	14,8	12,1	10,4	8,74	2,36	2,44	2,57	2,73	2,83	2,95
	40	17,1	15,7	13,7	11,3	9,75	8,24	2,01	2,09	2,21	2,32	2,39	2,48
	45	15,8	14,6	12,7	10,6	9,27	7,95	1,72	1,79	1,89	1,99	2,06	2,13
7	20	24,0	22,0	19,0	15,5	13,4	11,2	3,78	3,98	4,33	4,84	5,21	5,63
	25	22,6	20,8	18,0	14,6	12,5	10,4	3,27	3,44	3,72	4,08	4,33	4,63
	30	21,2	19,6	16,9	13,7	11,7	9,76	2,83	2,98	3,20	3,45	3,62	3,83
	35	19,6	18,1	15,7	12,8	10,9	9,10	2,42	2,53	2,69	2,86	2,98	3,12
	40	18,2	16,8	14,6	11,9	10,3	8,62	2,07	2,17	2,31	2,44	2,52	2,62
	45	17,1	15,9	13,8	11,4	9,95	8,45	1,81	1,89	2,01	2,13	2,20	2,28
12	20	27,3	25,2	21,8	17,6	14,9	12,3	3,92	4,20	4,67	5,29	5,74	6,30
	25	25,8	23,9	20,7	16,6	14,0	11,5	3,44	3,69	4,06	4,50	4,82	5,22
	30	24,2	22,5	19,5	15,6	13,2	10,8	3,03	3,24	3,53	3,85	4,07	4,34
	35	22,4	20,8	18,1	14,5	12,3	10,0	2,57	2,74	2,98	3,19	3,35	3,53
	40	20,9	19,5	17,0	13,7	11,6	9,57	2,23	2,38	2,57	2,73	2,85	2,98
	45	20,4	19,0	16,6	13,6	11,6	9,71	2,01	2,14	2,31	2,46	2,56	2,68
15	20	29,4	27,2	23,7	19,4	16,6	13,9	4,08	4,42	4,96	5,65	6,14	6,75
	25	27,6	25,6	22,3	18,1	15,5	12,9	3,51	3,79	4,21	4,70	5,05	5,47
	30	25,8	24,0	20,9	17,0	14,5	12,0	3,02	3,26	3,59	3,93	4,17	4,46
	35	23,9	22,3	19,5	15,8	13,5	11,2	2,60	2,80	3,06	3,30	3,47	3,67
	40	22,6	21,1	18,5	15,1	13,0	10,8	2,28	2,45	2,67	2,85	2,98	3,12
	45	23,2	21,6	19,0	15,7	13,6	11,6	2,12	2,28	2,48	2,65	2,77	2,90
18	20	31,6	29,2	25,4	20,9	18,1	15,3	4,46	4,83	5,45	6,28	6,87	7,56
	25	29,6	27,4	23,9	19,5	16,9	14,2	3,87	4,18	4,66	5,25	5,68	6,17
	30	27,7	25,6	22,4	18,3	15,7	13,2	3,35	3,61	3,99	4,42	4,71	5,06
	35	25,9	24,0	21,0	17,2	14,8	12,4	2,92	3,16	3,48	3,79	4,00	4,25
	40	24,6	22,8	20,0	16,5	14,2	12,0	2,57	2,76	3,01	3,25	3,42	3,60
	45	25,0	23,3	20,5	17,0	14,9	12,8	2,46	2,64	2,88	3,12	3,27	3,44

To = Leaving internal exchanger water temperature (°C)

Tae [°C] = External exchanger inlet air temperature

Performances in function of the inlet/outlet water temperature differential = 5°C

Cooling capacity and EER calculated according to EN 14511:2013

# WSA-XIN 121 Performance

## Cooling

To	Tae	Cooling capacity						EER					
		100%	80%	75%	60%	50%	40%	100%	80%	75%	60%	50%	40%
5	20	28,9	26,6	22,8	18,9	16,3	13,7	3,88	4,03	4,33	4,70	4,93	5,15
	25	27,4	25,3	21,7	17,8	15,3	12,8	3,39	3,51	3,74	4,00	4,16	4,32
	30	25,9	23,9	20,5	16,9	14,5	12,1	2,96	3,07	3,24	3,42	3,53	3,64
	35	23,8	22,0	19,0	15,6	13,4	11,2	2,52	2,60	2,72	2,83	2,91	2,98
	40	21,9	20,2	17,5	14,4	12,5	10,5	2,14	2,21	2,31	2,40	2,45	2,50
	45	19,7	18,3	15,9	13,3	11,6	9,87	1,79	1,85	1,94	2,01	2,06	2,10
7	20	30,7	28,3	24,3	19,9	17,1	14,3	4,10	4,28	4,62	5,02	5,27	5,51
	25	29,1	26,9	23,0	18,8	16,1	13,3	3,57	3,72	3,98	4,26	4,44	4,61
	30	27,4	25,4	21,8	17,8	15,1	12,5	3,11	3,24	3,44	3,63	3,75	3,87
	35	25,3	23,4	20,2	16,4	14,0	11,6	2,65	2,75	2,89	3,02	3,10	3,18
	40	23,1	21,5	18,5	15,2	13,1	10,9	2,24	2,34	2,45	2,55	2,61	2,66
	45	21,0	19,6	16,9	14,1	12,2	10,3	1,89	1,96	2,06	2,15	2,20	2,25
12	20	35,2	32,7	28,0	22,6	19,1	15,7	4,64	4,91	5,35	5,83	6,13	6,41
	25	33,2	30,9	26,4	21,3	17,9	14,5	4,01	4,24	4,58	4,91	5,13	5,33
	30	31,1	29,0	24,9	20,0	16,8	13,6	3,47	3,67	3,93	4,16	4,31	4,44
	35	28,9	27,0	23,1	18,6	15,7	12,7	2,96	3,12	3,33	3,49	3,59	3,68
	40	26,4	24,7	21,3	17,2	14,5	11,9	2,51	2,65	2,81	2,92	3,00	3,06
	45	24,3	22,7	19,7	16,1	13,7	11,4	2,13	2,25	2,39	2,49	2,56	2,62
15	20	37,9	35,2	30,3	24,9	21,3	17,8	4,81	5,13	5,65	6,19	6,54	6,88
	25	35,7	33,2	28,6	23,4	19,9	16,5	4,13	4,40	4,79	5,18	5,43	5,67
	30	33,4	31,2	26,9	21,9	18,6	15,4	3,55	3,78	4,09	4,36	4,53	4,70
	35	30,9	28,9	24,9	20,3	17,3	14,3	3,02	3,22	3,46	3,64	3,76	3,88
	40	28,2	26,4	22,9	18,8	16,1	13,4	2,55	2,72	2,90	3,04	3,13	3,21
	45	26,3	24,6	21,5	17,8	15,4	13,0	2,20	2,34	2,51	2,63	2,71	2,79
18	20	40,4	37,4	32,2	26,7	23,0	19,4	5,14	5,47	6,05	6,71	7,12	7,54
	25	38,0	35,3	30,4	25,0	21,5	18,0	4,40	4,68	5,13	5,60	5,91	6,20
	30	35,6	33,1	28,6	23,5	20,1	16,8	3,78	4,02	4,37	4,71	4,92	5,13
	35	32,8	30,6	26,5	21,7	18,7	15,6	3,23	3,45	3,73	3,97	4,12	4,27
	40	30,1	28,1	24,3	20,1	17,3	14,6	2,74	2,90	3,12	3,30	3,42	3,53
	45	28,3	26,5	23,1	19,3	16,8	14,3	2,39	2,53	2,73	2,89	2,99	3,10

To = Leaving internal exchanger water temperature (°C)

Tae [°C] = External exchanger inlet air temperature

Performances in function of the inlet/outlet water temperature differential = 5°C

Cooling capacity and EER calculated according to EN 14511:2013

# WSA-XIN 131 Performance

## Cooling

To	Tae	Cooling capacity						EER					
		100%	80%	75%	60%	50%	40%	100%	80%	75%	60%	50%	40%
5	20	31,9	29,2	25,1	20,8	17,9	14,9	3,67	3,79	3,95	4,21	4,36	4,45
	25	30,2	27,7	24,0	19,8	16,9	14,0	3,20	3,31	3,45	3,63	3,73	3,79
	30	28,6	26,3	22,9	18,8	16,0	13,2	2,79	2,89	3,02	3,15	3,21	3,25
	35	26,3	24,2	21,1	17,4	14,8	12,3	2,37	2,44	2,53	2,61	2,65	2,68
	40	24,0	22,2	19,4	16,1	13,8	11,5	2,01	2,08	2,18	2,24	2,27	2,28
	45	21,8	20,1	17,6	14,7	12,7	10,8	1,69	1,75	1,83	1,89	1,92	1,94
7	20	33,9	31,1	26,9	22,2	18,9	15,6	3,84	4,01	4,23	4,52	4,68	4,78
	25	32,0	29,5	25,7	21,1	17,9	14,7	3,34	3,48	3,68	3,88	3,99	4,06
	30	30,2	27,8	24,4	19,9	16,9	13,8	2,90	3,03	3,21	3,35	3,42	3,46
	35	27,8	25,7	22,6	18,5	15,7	12,9	2,48	2,57	2,71	2,80	2,85	2,88
	40	25,5	23,6	20,7	17,1	14,5	12,0	2,10	2,19	2,32	2,39	2,43	2,44
	45	23,2	21,5	18,9	15,7	13,5	11,3	1,77	1,85	1,96	2,02	2,06	2,08
12	20	38,8	35,8	31,5	25,6	21,5	17,5	4,27	4,53	4,90	5,28	5,48	5,60
	25	36,5	33,8	29,8	24,2	20,2	16,3	3,68	3,91	4,24	4,51	4,65	4,72
	30	34,2	31,8	28,1	22,8	19,0	15,3	3,18	3,39	3,67	3,86	3,95	4,00
	35	31,7	29,5	26,2	21,2	17,8	14,3	2,73	2,91	3,16	3,28	3,34	3,37
	40	29,1	27,1	24,1	19,6	16,5	13,4	2,32	2,47	2,69	2,78	2,82	2,85
	45	26,7	24,9	22,2	18,2	15,5	12,7	1,96	2,09	2,27	2,36	2,40	2,43
15	20	41,7	38,6	34,0	28,0	23,8	19,6	4,39	4,71	5,16	5,61	5,86	6,04
	25	39,2	36,4	32,2	26,4	22,4	18,3	3,79	4,07	4,46	4,78	4,96	5,08
	30	36,8	34,2	30,4	24,9	21,0	17,2	3,28	3,52	3,87	4,09	4,21	4,29
	35	33,8	31,5	28,1	23,0	19,5	15,9	2,78	2,98	3,28	3,44	3,52	3,57
	40	31,1	29,0	25,9	21,3	18,2	15,0	2,37	2,55	2,80	2,92	2,98	3,02
	45	29,0	27,0	24,1	20,1	17,2	14,4	2,05	2,20	2,41	2,52	2,59	2,63
18	20	44,1	40,7	35,6	29,5	25,3	21,1	4,67	5,00	5,46	6,00	6,31	6,54
	25	41,4	38,3	33,7	27,8	23,7	19,6	4,01	4,29	4,69	5,08	5,31	5,48
	30	38,7	35,9	31,7	26,1	22,2	18,3	3,45	3,69	4,04	4,32	4,48	4,60
	35	35,9	33,3	29,5	24,3	20,7	17,2	2,96	3,19	3,51	3,72	3,83	3,91
	40	32,9	30,5	27,1	22,5	19,2	16,0	2,51	2,69	2,94	3,10	3,19	3,26
	45	30,8	28,7	25,4	21,3	18,4	15,6	2,19	2,34	2,56	2,71	2,79	2,86

To = Leaving internal exchanger water temperature (°C)

Tae [°C] = External exchanger inlet air temperature

Performances in function of the inlet/outlet water temperature differential = 5°C

Cooling capacity and EER calculated according to EN 14511:2013

## Accessories separately supplied

Every accessory is marked with a configuration code, for instance CMMBX.

When the letter X is placed at the end, this means that the accessory is supplied separately. If there is no X in the code, the accessory is mounted in the factory.

### AMRX - Rubber antivibration mounts

The rubber antivibration mounts reduce the vibrations of compressor during its operation and they are installed at the base toe.

### RCTX - Remote control

The RCTX remote control, is provided with a large and easy to read display. Programming, using only 4 keys, is intuitive and simple.

The device can also:

- control the unit's operation
- activate the circulation of the system's water
- set the unit set point water temperature according to time bands

The RCTX also works in "remote control", making it even easier to configure and control the unit's operation. It can:

- set the ON/OFF control
- read the information detected by the device installed on board the unit, as the operation status, parameters and alarms.

The unit is not activated if the room temperature set point has not been reached, but it is activated if the supply water temperature does not reach the set point programmed when setting the daily or weekly operating schedule.

The thermostat can be controlled at a maximum distance of 100 metres.



1. Clock
2. summer/winter/defrosting operating display
3. Ambient temperature
4. Alarm
5. UP + DOWN: operating time band setting
6. ON/OFF button
7. ESC +SET parameter programming
8. fan operating status (active)
9. compressor operating status (not active)
10. circulator operating status (active)

### GMX - Outlet grille

Protection grille to apply to the screw supply outlet as protection of the moving parts if the unit has been installed in an accessible position and not ducted

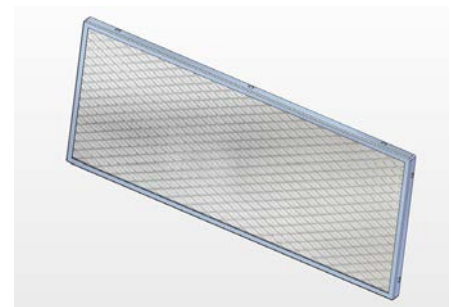

## CMSC2X - Serial communication module with RS485 serial converter kit

It is a serial communication module (Modbus) designed to be connected to a supervisor with the standard Modbus protocol.

Up to 127 units can be connected to a single supervision system.

The serial communication module fitted with the supervisor (Modbus) is required if the unit is connected to ELFOControl.

Use an RS 485 BUS to connect it to a PC.

## KTFL2X - 1" 1/4 water side hose kit

The kit is composed of: Two hoses, length 300 and diameter 1 1/4", required for connection of the unit to the system.

This kit can be used for 16 to 31kW heat pumps

## KSAX - 100-litre circuit breaker

Storage in Fe360b and anti-corrosion treatment with organic enamel, 50 mm-thick polyethylene and polyurethane external insulation and a maximum operating pressure of 6 bar.

Diameter 500 Height 900 8 connections.

Suitable for all WSA-XIN sizes



## KG4UP - Management kit up to 4 units in parallel

Module that, by the remote activation of the first and second set-point, allows to manage the unit operating in cascade, up to 4 units, balancing the operating hours. Each unit must be connected to the module that enables its operating by a potential-free contact.



# Dimensional drawings

DAAU9-81-101\_1 REV01  
DATA 19/05/2014

## Sizes 81-91-101

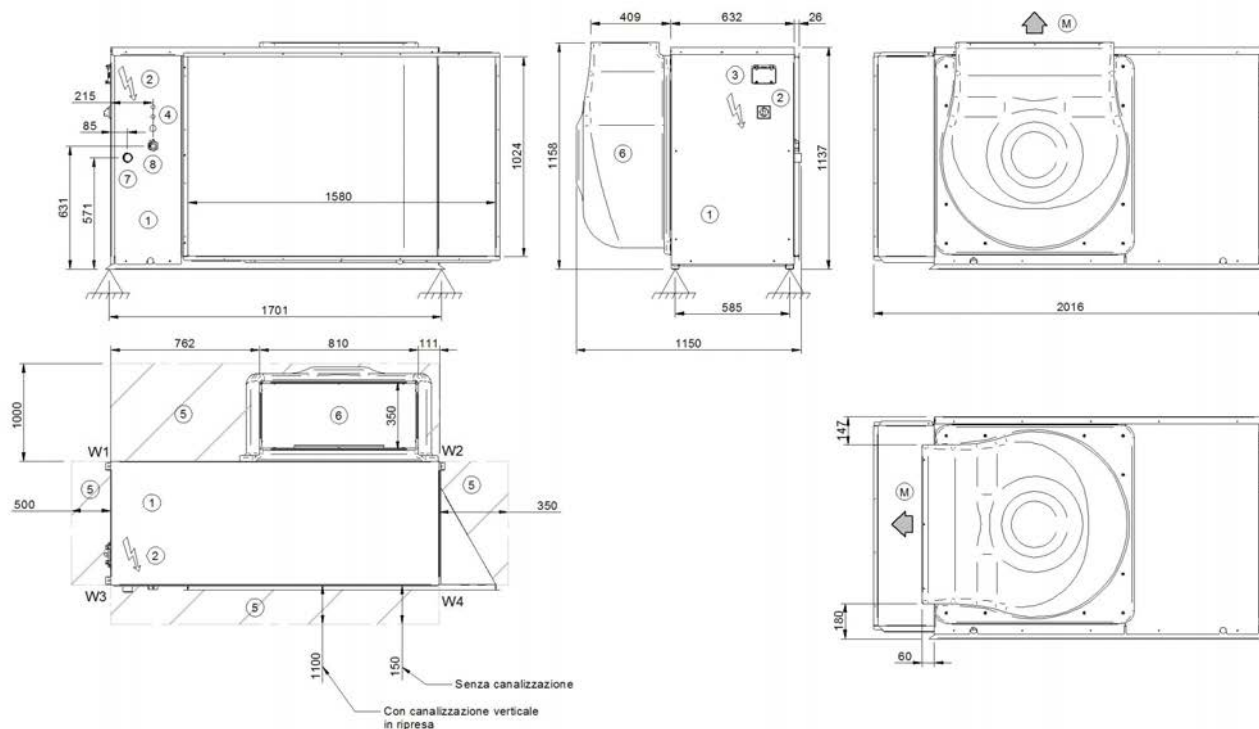

1. Compressor compartment
2. Electrical panel
3. Unit control keypad
4. Power input
5. Functional spaces
6. Electric fan (Supply)
7. internal exchanger water inlet (GAS F 1")
8. internal exchanger water outlet (GAS F 1")

(M) Air supply

Size		81	91	101
Length	mm	2016	2016	2016
Depth	mm	1150	1150	1150
Height	mm	1137	1137	1137
W1	kg	75	75	75
W2	kg	66	66	66
W3	kg	67,5	67,5	67,5
W4	kg	37,5	37,5	37,5
Operating weight	kg	246	246	246
Shipping weight	kg	250	250	250

The presence of optional accessories may result in a substantial variation of the weights shown in the table.

Sizes 121-131

DAAU9-121-141\_1 REV01  
DATA 19/05/2014

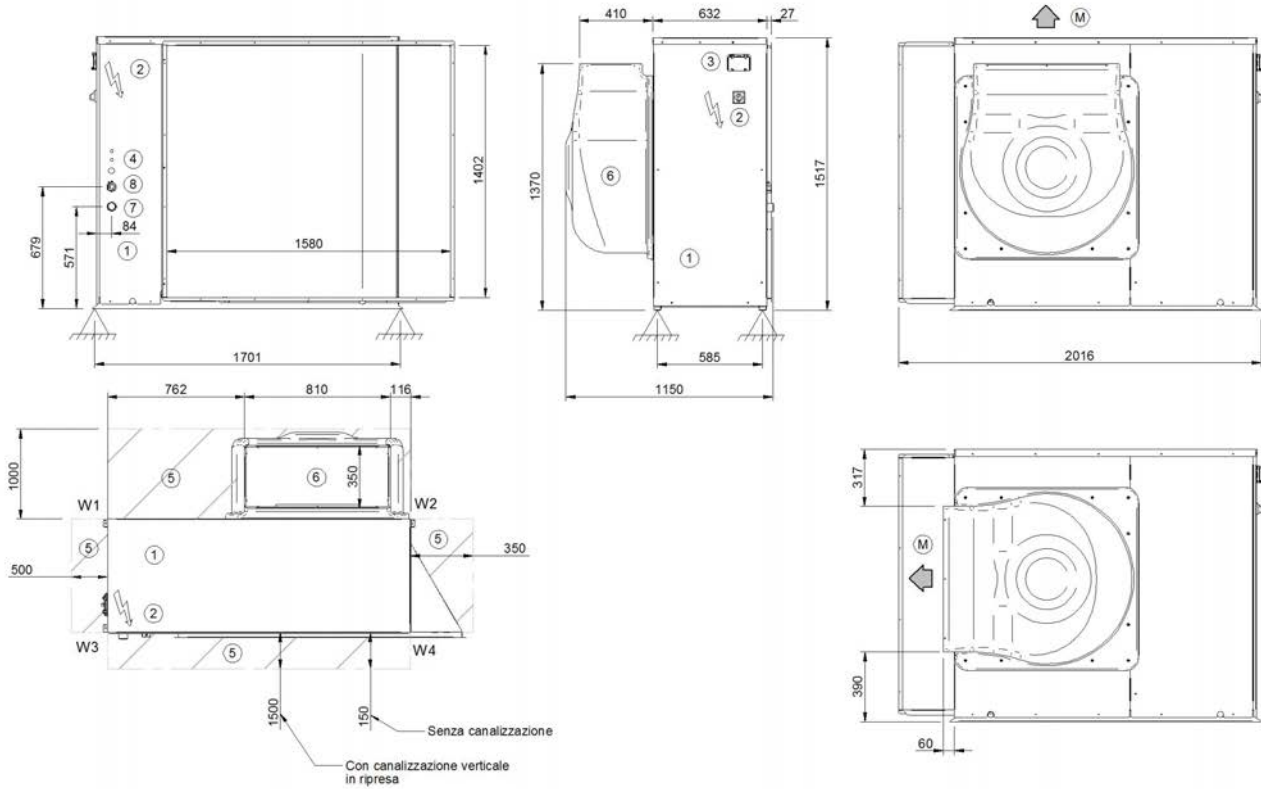

- 1. Compressor compartment
- 2. Electrical panel
- 3. Unit control keypad
- 4. Power input
- 5. Functional spaces
- 6. Electric fan (Supply)
- 7. internal exchanger water inlet (GAS F 1")
- 8. internal exchanger water outlet (GAS F 1")

(M)Air supply

Size		121	131
Length	mm	2016	2016
Depth	mm	1150	1150
Height	mm	1517	1517
W1	kg	82	82
W2	kg	86	86
W3	kg	83	83
W4	kg	58	58
Operating weight	kg	309	309
Shipping weight	kg	312	312

The presence of optional accessories may result in a substantial variation of the weights shown in the table.

Page intentionally left blank



**CLIVET SPA**

Via Camp Lonc 25, Z.I. Villapaiera - 32032 Feltre (BL) - Italy  
Tel. + 39 0439 3131 - Fax + 39 0439 313300 - info@clivet.it

**CLIVET GROUP UK Limited**

4 Kingdom Close, Segensworth East - Fareham, Hampshire - PO15 5TJ - United Kingdom  
Tel. + 44 (0) 1489 572238 - Fax + 44 (0) 1489 573033 - enquiries@clivetgroup.co.uk

**CLIVET GROUP UK Limited (Operations)**

Units F5&F6 Railway Triangle Ind Est, Walton Road - Portsmouth, Hampshire - PO6 1TG - United Kingdom  
Tel. +44 (0) 2392 381235 - Fax. +44 (0) 2392 381243 - service@clivetgroup.co.uk

**CLIVET ESPAÑA S.A.U.**

C/ Bac de Roda, 36 - 08019 Barcelona - España  
Tel: +34 93 8606248 - Fax +34 93 8855392 - info@clivet.es

Av.Manoterás Nº 38, Oficina C303 - 28050 Madrid - España  
Tel. +34 91 6658280 - Fax +34 91 6657806 - info@clivet.es

**CLIVET GmbH**

Hummelsbütteler Steindamm 84, 22851 Norderstedt - Germany  
Tel. + 49 (0) 40 32 59 57-0 - Fax + 49 (0) 40 32 59 57-194 - info.de@clivet.com

**CLIVET RUSSIA**

Elektrozavodskaya st. 24, office 509 - 107023, Moscow, Russia  
Tel. + 74956462009 - Fax + 74956462009 - info.ru@clivet.com

**CLIVET MIDEAST FZCO**

Dubai Silicon Oasis (DSO), High Bay Complex, Office N. 20, PO BOX 342009, Dubai, UAE  
Tel. + 9714 3208499 - Fax + 9714 3208216 - info@clivet.ae

**CLIVET AIRCONDITIONING SYSTEMS PRIVATE LIMITED**

4BA, Gundecha Onclave, Kherani Road - Sakinaka, Andheri (East) - Mumbai 400 072 - India  
Tel. +91 22 6193 7000 - Fax +91 22 6193 7001 - info.in@clivet.com

[www.clivet.com](http://www.clivet.com)  
[www.clivetlive.com](http://www.clivetlive.com)

A Group Company of

